

伸縮可撓管スーパーボール EB

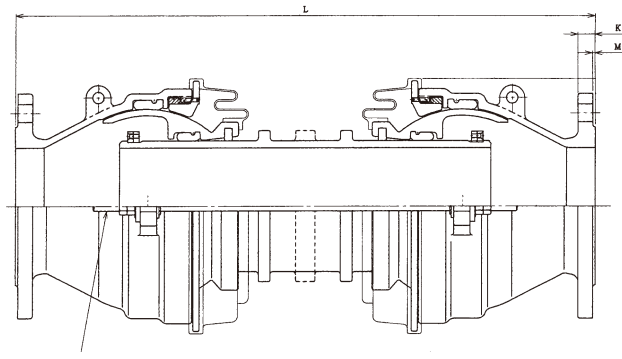

タイロッド

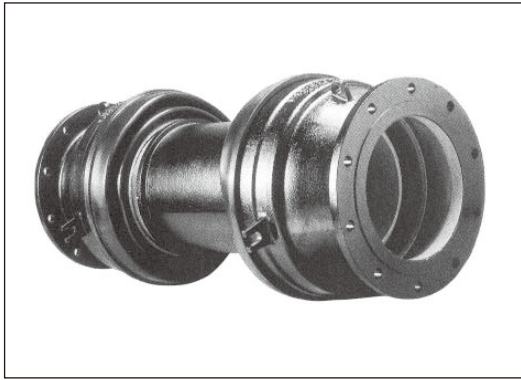
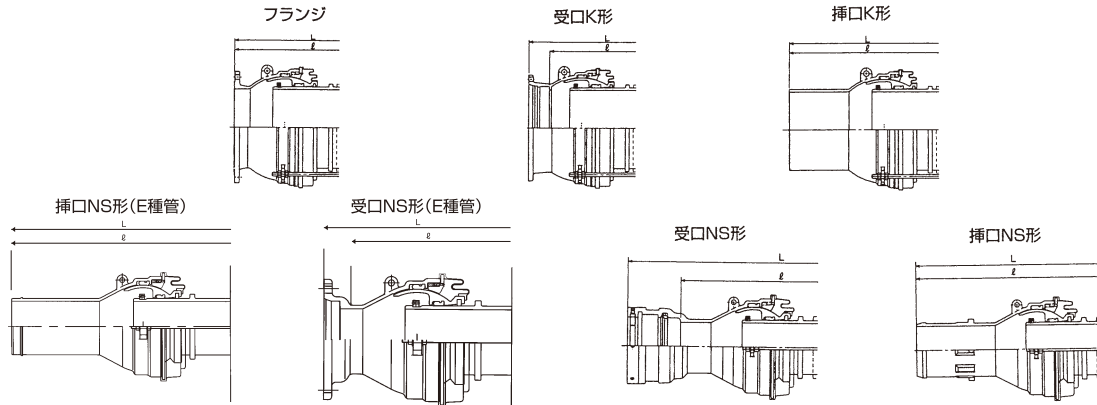

ダクタイル鋳鉄製 (フランジ・K形)

単位：円 寸法表

単位：mm

呼び径	口金	偏心量 (EB)						偏心量100		偏心量200		偏心量300	
		100	重量 (kg)	200	重量 (kg)	300	重量 (kg)	L	φ	L	φ	L	φ
50	F F	240,000	33.00	290,000	37.50	331,000	34.00	550	550	790	790	1,010	1,010
	F S	340,000	48.00	397,000	53.50	455,000	60.00	590	590	860	860	1,140	1,140
75	F S	335,000	46.00	391,000	51.50	447,000	79.00	720	720	990	990	1,270	1,270
	F U	343,000	47.00	400,000	52.50	459,000	59.00	600	520	870	790	1,150	1,070
	U U	340,000	47.00	408,000	52.50	461,000	59.00	610	450	880	720	1,160	1,000
	U S	335,000	56.00	393,000	51.50	451,000	58.00	730	650	1,000	920	1,280	1,200
	S S	325,000	45.50	385,000	51.00	439,000	57.50	850	850	1,120	1,120	1,400	1,400
	S S	325,000	45.50	385,000	51.00	439,000	57.50	850	850	1,120	1,120	1,400	1,400
100	F F	449,000	67.00	529,000	73.50	618,000	81.00	630	630	910	910	1,180	1,180
	F S	443,000	64.00	521,000	71.50	611,000	79.00	770	770	1,050	1,050	1,320	1,320
	F U	449,000	65.00	529,000	72.50	618,000	80.00	650	570	930	850	1,200	1,120
	U U	451,000	65.00	530,000	72.50	618,000	80.00	670	510	950	790	1,220	1,060
	U S	443,000	64.00	521,000	71.50	612,000	79.00	790	710	1,070	990	1,340	1,260
	S S	438,000	63.50	514,000	71.00	603,000	78.50	910	910	1,190	1,190	1,460	1,460
150	F F	598,000	90.00	742,000	101.50	866,000	110.00	670	670	980	980	1,280	1,280
	F S	588,000	98.50	730,000	101.00	853,000	113.50	810	810	1,120	1,120	1,420	1,420
	F U	599,000	90.00	743,000	99.50	866,000	112.00	690	610	1,000	920	1,300	1,220
	U U	599,000	101.00	744,000	102.50	867,000	115.00	710	550	1,020	860	1,320	1,160
	U S	591,000	90.50	730,000	100.00	856,000	112.50	830	750	1,140	1,060	1,440	1,360
	S S	573,000	91.00	720,000	102.50	848,000	115.00	950	950	1,260	1,260	1,560	1,560
200	F F	773,000	129.00	943,000	142.50	1,113,000	160.00	740	740	1,050	1,050	1,370	1,370
	F S	773,000	132.50	943,000	150.00	1,074,000	169.50	880	880	1,190	1,190	1,510	1,510
	F U	750,000	131.00	951,000	148.50	1,076,000	168.00	750	670	1,060	980	1,380	1,300
	U U	779,000	129.00	951,000	146.50	1,082,000	166.00	760	600	1,070	910	1,390	1,230
	U S	777,000	133.50	944,000	151.00	1,072,000	170.50	890	810	1,200	1,120	1,520	1,440
	S S	769,000	135.00	937,000	152.50	1,065,000	172.00	1,020	1,020	1,330	1,330	1,650	1,650

※フランジは7.5K仕様です。高圧仕様はお問い合わせ下さい。 ※接合部付属品は含まれておりません。
 ※0.75Mpaタイロッドが標準で付属しております。1.0Mpa以上のタイロッドに関してはお問い合わせ下さい。

伸縮可撓管スーパーボール EB

ダクタイトル鑄鉄製（フランジ・K形）

単位：円 寸法表

単位：mm

呼び径	口金	偏芯量(EB)						偏芯量100		偏芯量200		偏芯量300	
		100	重量(kg)	200	重量(kg)	300	重量(kg)	L	φ	L	φ	L	φ
250	FF	955,000	185.00	1,167,000	209.50	1,320,000	235.00	790	790	1,130	1,130	1,460	1,460
	FS	950,000	194.00	1,158,000	223.50	1,313,000	247.00	930	930	1,270	1,270	1,600	1,600
	FU	953,000	189.00	1,165,000	218.50	1,320,000	242.00	800	720	1,140	1,060	1,470	1,390
	UU	943,000	186.00	1,155,000	215.50	1,312,000	239.00	810	650	1,150	990	1,480	1,320
	US	942,000	191.00	1,151,000	220.50	1,304,000	244.00	940	860	1,280	1,200	1,610	1,530
	SS	936,000	196.00	1,145,000	226.50	1,297,000	250.00	1,070	1,070	1,410	1,410	1,740	1,740
300	FF	1,122,000	236.00	1,343,000	276.50	1,510,000	301.00	850	850	1,180	1,180	1,530	1,530
	FS	1,105,000	254.00	1,320,000	284.50	1,487,000	317.00	1,020	1,020	1,350	1,350	1,700	1,700
	FU	1,119,000	248.00	1,343,000	278.50	1,507,000	311.00	890	780	1,220	1,110	1,570	1,460
	UU	1,107,000	248.00	1,340,000	278.50	1,507,000	311.00	930	710	1,260	1,040	1,610	1,390
	US	1,096,000	254.00	1,316,000	284.50	1,484,000	317.00	1,060	950	1,390	1,280	1,740	1,630
	SS	1,084,000	260.00	1,297,000	290.50	1,466,000	323.00	1,190	1,190	1,520	1,520	1,870	1,870
350	FF	1,487,000	331.00	1,593,000	360.50	1,895,000	397.00	970	970	1,280	1,280	1,660	1,660
	FS	1,436,000	336.00	1,544,000	365.50	1,845,000	402.00	1,195	1,195	1,505	1,505	1,885	1,885
	FU	1,471,000	329.00	1,587,000	358.50	1,880,000	395.00	995	885	1,305	1,195	1,685	1,575
	UU	1,452,000	327.00	1,594,000	373.50	1,902,000	410.00	1,020	800	1,330	1,110	1,710	1,490
	US	1,417,000	349.00	1,528,000	378.50	1,839,000	415.00	1,220	1,110	1,530	1,420	1,910	1,800
	SS	1,400,000	354.00	1,496,000	383.50	1,796,000	420.00	1,420	1,420	1,730	1,730	2,110	2,110
400	FF	1,904,000	410.00	2,000,000	452.50	2,437,000	500.00	1,020	1,020	1,340	1,340	1,730	1,730
	FS	1,822,000	416.00	1,938,000	458.50	2,377,000	506.00	1,255	1,255	1,575	1,575	1,965	1,965
	FU	1,879,000	405.00	1,991,000	447.50	2,365,000	495.00	1,035	925	1,355	1,245	1,745	1,635
	UU	1,854,000	416.00	1,990,000	458.50	2,421,000	506.00	1,050	830	1,370	1,150	1,760	1,540
	US	1,824,000	428.00	1,929,000	470.50	2,368,000	518.00	1,270	1,160	1,590	1,480	1,980	1,870
	SS	1,781,000	440.00	1,887,000	482.50	2,318,000	530.00	1,490	1,490	1,810	1,810	2,200	2,200
450	FF	2,353,000	514.00	2,444,000	564.50	2,974,000	623.00	1,050	1,050	1,360	1,360	1,740	1,740
	FS	2,307,000	517.00	2,431,000	567.50	2,964,000	626.00	1,285	1,285	1,595	1,595	1,975	1,975
	FU	2,386,000	507.00	2,728,000	557.50	2,985,000	616.00	1,075	965	1,385	1,275	1,765	1,655
	UU	2,409,000	515.00	2,556,000	565.50	2,995,000	624.00	1,100	880	1,410	1,190	1,790	1,570
	US	2,335,000	527.00	2,431,000	577.50	2,964,000	636.00	1,310	1,200	1,620	1,510	2,000	1,890
	SS	2,255,000	540.00	2,401,000	590.50	2,933,000	649.00	1,520	1,520	1,830	1,830	2,210	2,210
500	FF	2,694,000	593.00	2,719,000	647.50	3,386,000	728.00	1,060	1,060	1,410	1,410	1,820	1,820
	FS	2,659,000	598.00	2,709,000	652.50	3,594,000	733.00	1,300	1,300	1,650	1,650	2,060	2,060
	FU	2,709,000	585.00	3,048,000	639.50	3,404,000	720.00	1,085	975	1,435	1,325	1,845	1,735
	UU	2,727,000	794.00	2,814,000	587.50	3,421,000	929.00	1,110	890	1,460	1,240	1,870	1,650
	US	2,678,000	725.00	2,731,000	779.50	3,394,000	860.00	1,325	1,215	1,675	1,565	2,085	1,975
	SS	2,619,000	656.00	2,699,000	710.50	3,349,000	791.00	1,540	1,540	1,890	1,890	2,300	2,300

ダクタイトル鑄鉄製（NS形E種管）

単位：円 寸法表

単位：mm

呼び径	口金	偏芯量(EB)						偏芯量100		偏芯量200		偏芯量300	
		100	重量(kg)	200	重量(kg)	300	重量(kg)	L	φ	L	φ	L	φ
75	FS	426,000	45.00	484,000	50.00	537,000	56.00	770	770	1,040	1,040	1,320	1,320
	FU	474,000	48.00	532,000	53.00	578,000	59.00	600	561	870	831	1,150	1,111
	UU	592,000	49.00	645,000	54.00	689,000	60.00	610	532	880	802	1,160	1,082
	US	544,000	47.00	598,000	52.00	653,000	58.00	780	741	1,050	1,011	1,330	1,291
	SS	499,000	44.00	550,000	49.00	607,000	55.00	950	950	1,220	1,220	1,500	1,500
100	FS	546,000	63.00	591,000	70.00	649,000	77.00	810	810	1,090	1,090	1,360	1,360
	FU	592,000	66.00	638,000	73.00	696,000	80.00	650	611	930	891	1,200	1,161
	UU	704,000	68.00	750,000	75.00	805,000	82.00	670	592	950	872	1,220	1,142
	US	667,000	65.00	702,000	72.00	757,000	79.00	830	791	1,110	1,071	1,380	1,341
	SS	612,000	61.00	653,000	68.00	708,000	75.00	990	990	1,270	1,270	1,540	1,540
150	FS	697,000	91.00	837,000	100.00	934,000	112.00	900	900	1,210	1,210	1,510	1,510
	FU	743,000	93.00	883,000	102.00	980,000	114.00	690	651	1,000	961	1,300	1,261
	UU	849,000	107.00	982,000	108.00	1,082,000	120.00	710	632	1,020	942	1,320	1,242
	US	804,000	105.00	935,000	106.00	1,035,000	118.00	920	881	1,230	1,191	1,530	1,491
	SS	757,000	103.00	888,000	104.00	989,000	116.00	1,130	1,130	1,440	1,440	1,740	1,740

伸縮可撓管スーパーボールEB (NS形)

ダクタイル鋳鉄製

単位：円 寸法表

単位：mm

呼び径	口金	偏心量 (EB)						偏心量100		偏心量200		偏心量300	
		100	重量 (kg)	200	重量 (kg)	300	重量 (kg)	L	φ	L	φ	L	φ
75	F S	408,000	47.00	459,000	52.50	499,000	59.00	775	775	1,045	1,045	1,325	1,325
	F U	461,000	52.00	521,000	57.50	552,000	64.00	674	520	944	790	1,224	1,070
	U U	582,000	56.00	622,000	61.50	685,000	68.00	758	450	1,028	720	1,308	1,000
	U S	530,000	51.00	578,000	56.50	629,000	63.00	859	705	1,129	975	1,409	1,255
	S S	486,000	45.00	535,000	50.50	585,000	57.00	960	960	1,230	1,230	1,510	1,510
100	F S	508,000	66.00	570,000	72.50	643,000	80.00	840	840	1,120	1,120	1,390	1,390
	F U	552,000	74.00	607,000	80.50	672,000	64.00	734	570	1,014	850	1,284	1,120
	U U	676,000	80.00	756,000	86.50	819,000	94.00	838	510	1,118	790	1,388	1,060
	U S	642,000	73.00	714,000	56.50	787,000	63.00	944	780	1,224	1,060	1,494	1,330
	S S	591,000	65.00	695,000	71.50	767,000	79.00	1,050	1,050	1,330	1,330	1,600	1,600
150	F S	695,000	90.00	808,000	101.50	936,000	111.00	885	885	1,195	1,195	1,495	1,495
	F U	734,000	101.00	865,000	112.50	994,000	122.00	780	610	1,090	920	1,390	1,220
	U U	944,000	111.00	1,021,000	122.50	1,149,000	132.00	890	550	1,200	860	1,500	1,160
	U S	850,000	100.00	932,000	111.50	1,057,000	121.00	995	825	1,305	1,135	1,605	1,435
	S S	808,000	90.00	902,000	101.50	1,032,000	111.00	1,100	1,100	1,410	1,410	1,710	1,710
200	F S	889,000	131.00	1,050,000	144.50	1,183,000	162.00	960	960	1,270	1,270	1,590	1,590
	F U	911,000	144.00	1,057,000	157.50	1,183,000	175.00	848	670	1,158	980	1,478	1,300
	U U	1,082,000	158.00	1,218,000	171.50	1,319,000	189.00	956	600	1,266	910	1,586	1,230
	U S	1,038,000	145.00	1,155,000	158.50	1,272,000	176.00	1,068	890	1,378	1,200	1,698	1,520
	S S	1,033,000	133.00	1,191,000	146.50	1,319,000	164.00	1,180	1,180	1,490	1,490	1,810	1,810
250	F S	1,155,000	190.00	1,304,000	214.50	1,501,000	240.00	1,010	1,010	1,350	1,350	1,680	1,680
	F U	1,194,000	203.00	1,333,000	229.50	1,524,000	253.00	898	720	1,238	1,060	1,568	1,390
	U U	1,359,000	221.00	1,471,000	245.50	1,649,000	271.00	1,006	650	1,346	990	1,676	1,320
	U S	1,352,000	207.00	1,416,000	231.50	1,574,000	257.00	1,118	940	1,458	1,280	1,788	1,610
	S S	1,277,000	194.00	1,410,000	218.50	1,599,000	244.00	1,230	1,230	1,570	1,570	1,900	1,900
300	F S	1,277,000	275.00	1,443,000	307.50	1,632,000	339.50	1,165	1,165	1,495	1,495	1,845	1,845
	F U	1,303,000	272.00	1,513,000	303.50	1,692,000	336.00	921	780	1,251	1,110	1,601	1,460
	U U	1,564,000	297.00	1,748,000	317.50	1,930,000	359.00	992	710	1,322	1,040	1,672	1,390
	U S	1,518,000	301.00	1,686,000	331.50	1,884,000	364.00	1,236	1,095	1,566	1,425	1,916	1,775
	S S	1,474,000	303.00	1,640,000	333.00	1,825,000	367.00	1,480	1,480	1,810	1,810	2,160	2,160
350	F S	1,578,000	380.00	1,699,000	380.70	1,990,000	418.00	1,300	1,300	1,610	1,610	1,990	1,990
	F U	1,669,000	353.00	1,793,000	371.70	2,096,000	418.00	1,026	885	1,336	1,195	1,716	1,575
	U U	1,941,000	394.00	2,084,000	423.00	2,372,000	459.00	1,082	800	1,392	1,110	1,772	1,490
	U S	1,852,000	450.00	1,975,000	423.50	2,263,000	457.00	1,356	1,215	1,666	1,525	2,046	1,905
	S S	1,757,000	390.00	1,865,000	419.00	2,153,000	455.00	1,630	1,630	1,940	1,940	2,320	2,230
400	F S	1,940,000	434.00	2,095,000	478.50	2,519,000	526.00	1,355	1,355	1,675	1,675	2,065	2,065
	F U	2,162,000	426.00	2,286,000	469.50	2,739,000	515.00	1,068	925	1,388	1,245	1,778	1,635
	U U	2,481,000	460.00	2,576,000	512.00	3,060,000	530.00	1,116	830	1,436	1,150	1,826	1,540
	U S	2,262,000	469.00	2,417,000	511.00	2,839,000	558.00	1,403	1,260	1,723	1,580	2,113	1,970
	S S	2,042,000	478.00	2,197,000	520.00	2,619,000	567.00	1,690	1,690	2,010	2,010	2,400	2,400
450	F S	2,370,000	553.00	2,621,000	603.00	3,096,000	661.00	1,395	1,395	1,705	1,705	2,085	2,085
	F U	2,728,000	535.00	2,859,000	585.00	3,383,000	643.00	1,108	965	1,418	1,275	1,798	1,665
	U U	3,367,000	573.00	3,499,000	623.00	4,024,000	681.00	1,166	880	1,476	1,190	1,856	1,570
	U S	3,010,000	593.00	3,141,000	643.00	3,667,000	701.00	1,453	1,310	1,763	1,620	2,143	2,000
	S S	2,653,000	614.00	2,864,000	664.00	3,310,000	722.00	1,740	1,740	2,050	2,050	2,430	2,430

※フランジは7.5K仕様です。高圧仕様はお問い合わせ下さい。

※受口タイプには接合用付属品がついています。

※0.75Mpaタイロッドが標準で付属しております。1.0Mpa以上のタイロッドに関してはお問い合わせ下さい。

伸縮可撓管 スーパーボール EB(GX形)

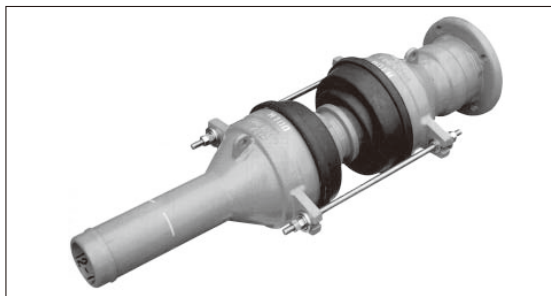

●EB-UGUG 鑄鉄管GX形受口×鑄鉄管GX形受口

●EB-UGSG 鑄鉄管GX形受口×鑄鉄管GX形挿口

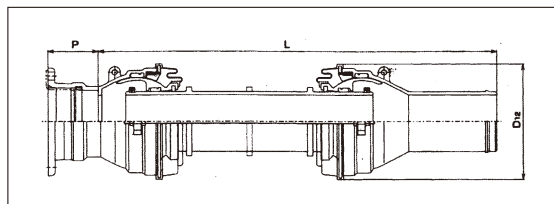

●EB-SGSG 鑄鉄管GX形挿口×鑄鉄管GX形挿口

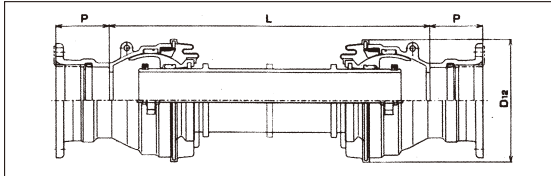
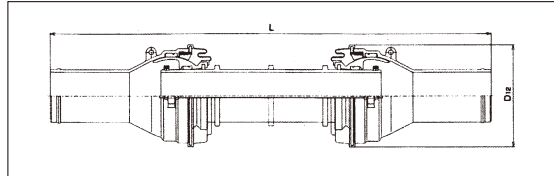

●EB-FUG 鑄鉄管フランジ形×鑄鉄管GX形受口

●EB-FSG 鑄鉄管フランジ形×鑄鉄管GX形挿口

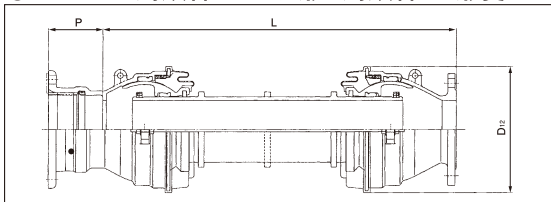
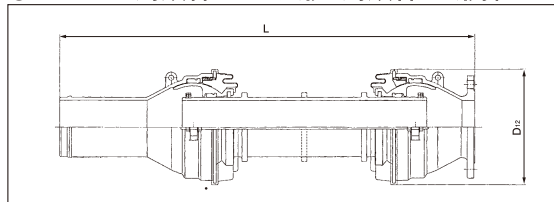

価格 寸法表

単位:mm

呼び径	口金	各部仕様								寸法				D12	P				
		偏芯量				伸び量	縮み量	L											
		100	重量(kg)	200	重量(kg)			300	重量(kg)	400	重量(kg)	偏芯量100	偏芯量200			偏芯量300	偏芯量400		
75	UU	717,000	55.00	778,000	64.00	831,000	68.00	902,000	71.00	40	40	450	720	1000	1280	233	136.5		
	US	662,000	52.00	723,000	56.00	788,000	63.00	844,000	69.00			740	1010	1290	1570		—		
	SS	608,000	49.00	668,000	52.00	733,000	61.00	790,000	65.00			1030	1300	1580	1860		—		
	FU	563,000	52.00	624,000	60.00	690,000	64.00	729,000	69.00			520	790	1070	1350		136.5		
	FS	509,000	49.00	573,000	50.00	623,000	61.00	678,000	66.00			810	1080	1360	1640		—		
100	UU	847,000	77.00	899,000	85.00	965,000	94.00	1,046,000	96.00			40	40	510	790	1060	1340	276	137.5
	US	803,000	67.90	844,000	78.00	908,000	86.00	991,000	72.00					790	1070	1340	1620		—
	SS	740,000	69.00	788,000	72.00	852,000	83.00	931,000	88.00					1070	1350	1620	1900		—
	FU	690,000	75.00	749,000	80.00	807,000	87.00	870,000	92.00					570	850	1120	1400		137.5
	FS	634,000	68.00	690,000	75.00	751,000	83.00	822,000	88.00					850	1130	1400	1680		—
150	UU	1,038,000	88.00	1,191,000	111.00	1,309,000	136.00	1,464,000	141.00	50	50			550	860	1160	1460	327	142.0
	US	984,000	102.00	1,136,000	110.00	1,253,000	121.00	1,396,000	133.00					825	1135	1435	1735		—
	SS	929,000	89.00	1,080,000	102.00	1,198,000	115.00	1,323,000	125.00					1100	1410	1710	2010		—
	FU	882,000	103.00	1,035,000	110.00	1,150,000	122.00	1,269,000	132.00					610	920	1220	1520		142.0
	FS	827,000	93.00	983,000	100.00	1,095,000	114.00	1,205,000	124.00					885	1195	1495	1795		—
200	UU	1,265,000	145.00	1,464,000	156.00	1,586,000	194.00	1,749,000	191.00			50	50	600	910	1230	1550	384	144.0
	US	1,214,000	140.00	1,412,000	164.00	1,533,000	178.00	1,710,000	188.00					885	1195	1515	1835		—
	SS	1,166,000	132.00	1,364,000	160.00	1,485,000	170.00	1,675,000	188.00					1170	1480	1800	2120		—
	FU	1,105,000	146.00	1,300,000	155.00	1,419,000	169.00	1,544,000	185.00					670	980	1300	1620		144.0
	FS	1,053,000	133.00	1,253,000	145.00	1,368,000	165.00	1,522,000	181.00					955	1265	1585	1905		—
250	UU	1,660,000	195.00	1,836,000	224.00	2,017,000	250.00	2,460,000	271.00	60	60			650	990	1320	1650	458	145.0
	US	1,638,000	210.00	1,775,000	220.00	1,955,000	247.00	2,369,000	268.00					935	1275	1605	1935		—
	SS	1,452,000	195.00	1,718,000	218.00	1,894,000	244.00	2,283,000	265.00					1220	1560	1890	2220		—
	FU	1,381,000	205.00	1,605,000	230.00	1,784,000	244.00	2,168,000	265.00					720	1060	1390	1720		145.0
	FS	1,304,000	192.00	1,548,000	215.00	1,720,000	241.00	2,121,000	262.00					1005	1345	1675	2005		—
300	UU	1,886,000	278.00	2,197,000	315.00	2,427,000	339.00	2,804,000	370.00			60	60	710	1040	1390	1740	514	150.0
	US	1,777,000	273.00	2,092,000	306.00	2,367,000	336.00	2,753,000	365.00					1095	1425	1775	2125		—
	SS	1,669,000	273.00	1,983,000	303.00	2,294,000	333.00	2,677,000	365.00					1480	1810	2160	2510		—
	FU	1,586,000	263.00	1,899,000	293.00	2,126,000	326.00	2,385,000	356.00					780	1110	1460	1810		150.0
	FS	1,480,000	260.00	1,791,000	290.00	2,050,000	323.00	2,290,000	353.00					1165	1495	1845	2195		—
350	UU	2,305,000	373.00	2,622,000	410.00	2,940,000	452.00	3,257,000	493.00	100	100			800	1110	1490	1860	577	150.0
	US	2,164,000	380.00	2,481,000	417.00	2,798,000	459.00	3,115,000	500.00					1215	1525	1905	2275		—
	SS	2,022,000	395.00	2,339,000	432.00	2,657,000	474.00	2,974,000	515.00					1630	1940	2320	2690		—
	FU	1,796,000	369.00	2,102,000	406.00	2,428,000	448.00	2,741,000	489.00					885	1195	1575	1945		150.0
	FS	1,654,000	384.00	1,961,000	421.00	2,286,000	463.00	2,599,000	504.00					1300	1610	1990	2360		—
400	UU	2,895,000	434.00	3,298,000	476.00	3,662,000	525.00	4,149,000	574.00			100	100	830	1150	1540	1920	632	152.0
	US	2,722,000	445.00	3,119,000	487.00	3,483,000	536.00	3,956,000	585.00					1260	1580	1970	2350		—
	SS	2,549,000	456.00	2,939,000	498.00	3,303,000	547.00	3,762,000	596.00					1690	2010	2400	2780		—
	FU	2,411,000	424.00	2,764,000	466.00	3,191,000	515.00	3,605,000	564.00					925	1245	1635	2015		152.0
	FS	2,235,000	435.00	2,580,000	477.00	3,007,000	526.00	3,407,000	575.00					1355	1675	2065	2445		—

※内面塗装は、JWWA G 112 水道用エポキシ樹脂粉末塗装により、膜厚は0.3mm以上とする。 ※外面塗装は、JDPA G 1049 GX形ダクタイル鑄鉄管より外面耐食塗装とする。
 ※片側フランジタイプの外面塗装は、JWWA K 139 一液性エポキシ樹脂塗装とする。但し、GX形受口及び挿口付きケースは、JDPA G 1049 GX形ダクタイル鑄鉄管により、外面耐食塗装とする。
 ※フランジは7.5K仕様です。高圧仕様はお問い合わせ下さい。 ※接合部付属品は含まれておりません。 ※0.75Mpaタイロッドが標準で付属しております。1.0Mpa以上のタイロッドに関してはお問い合わせ下さい。