

ビニロック筒型 CVRNS

(ゴム輪形硬質塩化ビニル管用離脱防止金具)

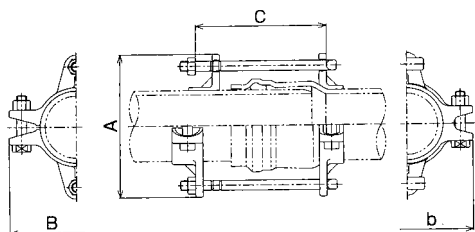

呼び径40~200



呼び径250~400

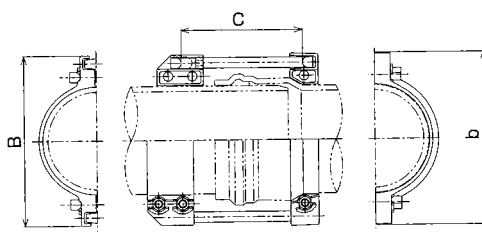

寸法表

単位:mm

呼び径	価格	B	A	b	C	重量(kg)
40	13,880	112	124	120	85	1.9
50	14,260	122	161	123	173	3.0
75	14,790	179	199	181	197	4.5
100	16,930	215	230	212	211	5.4
125	23,340	247	275	252	226	8.6
150	25,070	275	303	282	236	9.7
200	38,580	330	363	342	272	17.0
250	79,230	422	—	428	300	20.7
300	147,580	500	—	508	320	31.8
350	155,610	600	—	608	320	43.7
400	183,120	654	—	662	335	51.7

ビニロッケー体型 CVR1

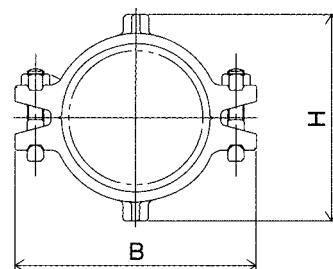
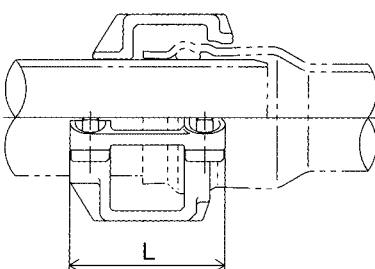
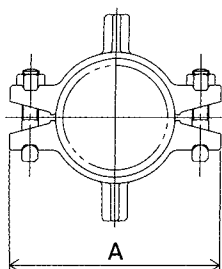

寸法表

単位:mm

呼び径	価格	L	H	A	B	重量(kg)
50	14,260	132	126	133	160	2.6
75	14,790	140	170	170	200	3.5
100	16,930	153	203	207	237	4.3
125	23,340	157	226	235	266	6.3
150	25,070	164	250	260	296	7.0

ビニロックソケット型 CVR-SK

(ゴム輪形硬質塩化ビニル管用のソケット用離脱防止金具)

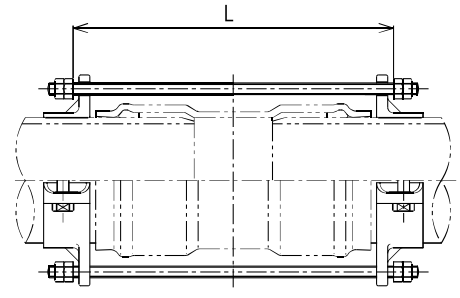
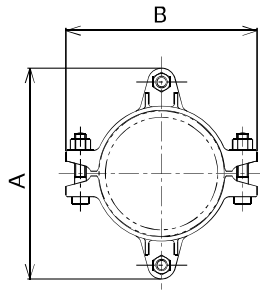
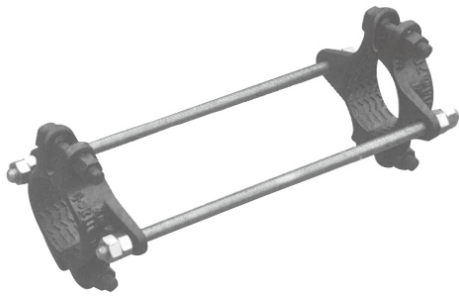

単位:mm

呼び径	価格	L	B	A	重量(kg)
50	25,390	350	122	161	3.3
75	25,870	384	179	199	4.6
100	27,620	404	215	230	5.4
125	37,640	428	247	275	8.4
150	39,440	458	275	303	9.9
200(セキスイ用)	60,500	618	330	363	16.4
200(クボタ用)	60,500	553			16.4

※呼び径200については塩化ビニル管メーカー名をご用命ください。

ビニロック筒型 受け挿し異径用 CVR-SKR

(ゴム輪形硬質塩化ビニル管用離脱防止金具)

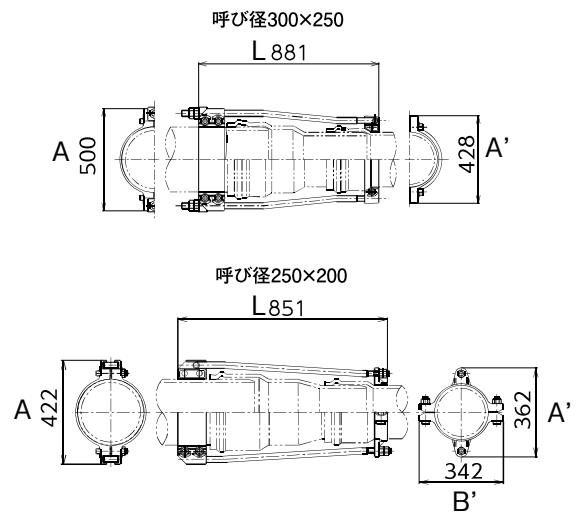
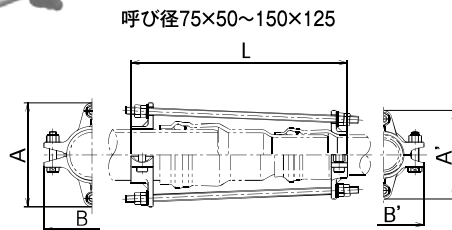
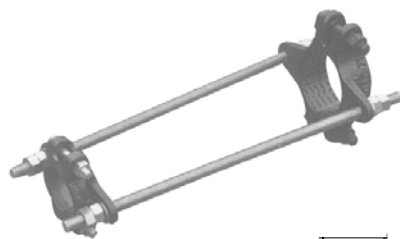

単位:mm

呼び径	価格	B	B'	A	A'	L	重量(kg)
75× 50	34,210	179	123	199	161	452	4.4
100× 75	36,300	215	181	230	199	483	5.3
125×100	42,050	247	212	275	230	530	8.0
150×100	45,990	275		303		608	9.3
150×125	48,200		252	363	275	592	10.8
200×150	63,680	330	282		303	736	15.1
250×200	260,930	上記の図面を参照してください。					35.0
300×250	333,340						55.0

ビニロック筒型ロングタイプ CVRNSL

(ゴム輪形硬質塩化ビニル管用離脱防止金具 (ロングタイプ))

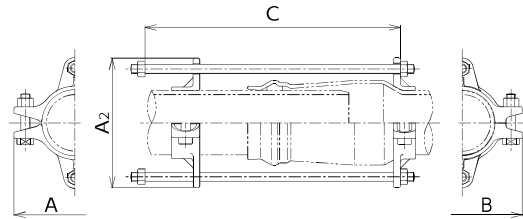
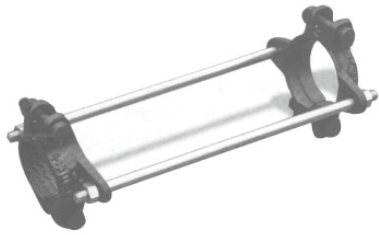

単位:mm

呼び径	価格	A	A ₂	B	C	重量(kg)
50	15,560	122	160	123	414	3.3
75	16,770	179	198	181	413	4.7
100	17,920	215	230	212	433	5.5
150	29,170	275	302	282	455	9.5
200	45,260	330	362	342	504	15.5

ビニロック筒型TS管用 CVRNTS

(硬質塩化ビニル管 (TS継手) 用離脱防止金具)

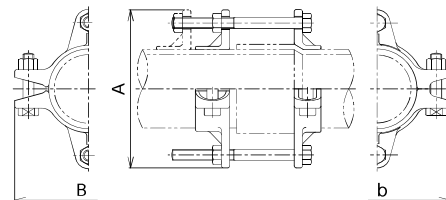

単位:mm

呼び径	価格	B	b	A	重量(kg)
50	14,650	122	123	161	2.8
75	15,000	179	181	199	4.1
100	17,410	215	212	230	4.9
125	21,280	247	252	275	8.6
150	25,740	275	282	303	9.1
200	39,630	330	342	363	17.0
250	92,070	422	428	—	25.7
300	125,550	500	508	—	38.4
350	169,100	600	608	—	46.1
400	229,070	654	662	—	61.4

ビニロックソケット型TS管用 CVRTS-SK
 (硬質塩化ビニル管 (TS継手) 用離脱防止金具)

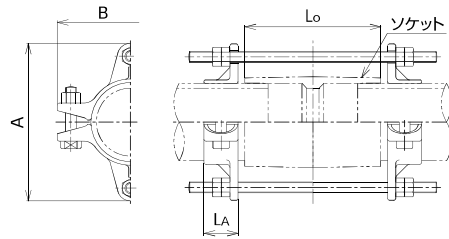
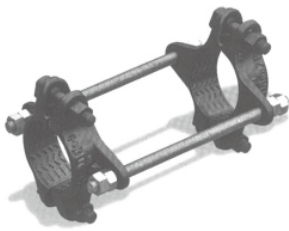

単位:mm

呼び径	価格	B	A	LA	L0	重量(kg)
50	22,030	122	161	35	133	3.1
75	22,610	179	199	45	155	3.7
100	24,980	215	230	50	200	5.2
125	33,660	247	275	55	230	8.3
150	34,690	275	303	60	300	9.9
200	54,510	330	363	80	550	16.3
250	103,570	—	422	115	700	33.3
300	205,070		500	125	850	52.3
350	249,020		608	125	900	89.4
400	305,290		662	125	1000	92.2

ビニロック爪型 CVRN

(ゴム輪形硬質塩化ビニル管×ダクタイル鋳鉄製異形管類用離脱防止金具)

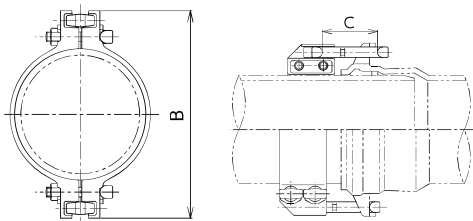

単位:mm

呼び径	価格	B	C	重量(kg)
50	9,480	161	71	1.7
75	9,860	199	91	2.5
100	11,270	230		3.1
125	15,540	275	98	3.6
150	16,650	303		5.0
200	29,550	364	110	8.3
250	56,320	422	136	12.6
300	86,040	500	147	20.9
350	101,350	600		26.0
400	110,070	654		28.4

※呼び径350・400については、相手方が爪付仕様か確認してください。